

EVALUATION AND IMPROVEMENT OF AM ANTENNA CHARACTERISTICS FOR OPTIMAL DIGITAL PERFORMANCE

Ronald D. Rackley, P.E.

du Treil, Lundin & Rackley, Inc.
Sarasota, Florida

INTRODUCTION

AM digital transmission places high demands on antenna system bandwidth, both from the standpoint of the input impedance at the transmitter load - which can cause noisy analog reception - and the antenna's far-field radiation characteristics, which can erode the error-correction capability of the digital signal and make its reception inconsistent. Directional antenna systems present the additional complication of sideband phase and amplitude errors resulting from changes in pattern shape with frequency, which can render digital modulation un-decodable in areas with satisfactory analog reception.

AM In-Band-On-Channel (IBOC) digital transmission technology is currently moving from the realm of the theoretical into the "real World" and, although the body of on-the-air experience with it is limited, it is rapidly expanding. Measurements can be made to evaluate the important aspects of antenna performance and, in many cases where performance is found to be lacking, relatively simple measures can be taken to improve matters.

MODULATION BASICS

As the ultimate goal in digital transmission is to have the signal pass through the antenna system and arrive at the receiver with its components in their correct relationships, it is best to start with an understanding of the nature of those components and how they might be affected by the transmission system. Digital modulation is accomplished by varying both the amplitude and the angle of the RF carrier simultaneously to transmit the digital bits that are decoded in the receiver. In the case of IBOC transmission such as is presently being introduced in the USA, this is done while still transmitting the conventional AM signal by sending the digital information at a low level so that the resulting occupied spectrum fits within the "RF mask" of an AM channel as defined in the FCC Rules.

A conventional AM signal is modulated in amplitude only, and has an uncomplicated spectral display that is directly related to the spectral content of the modulating audio. For single-frequency (sinusoidal) audio modulation, the RF envelope waveform is produced by two sidebands separated from the RF carrier frequency by the modulating signal's frequency. For 100-percent modulation, each sideband is one-half the amplitude of the carrier.

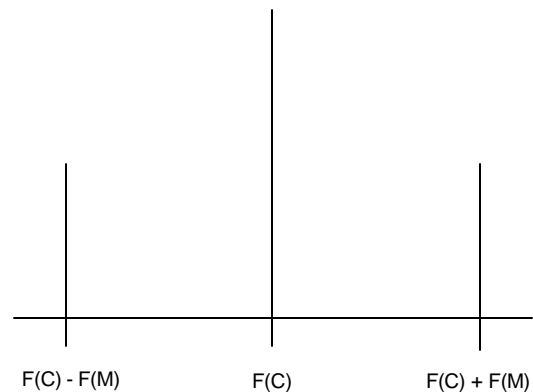

AM SINUSOIDAL MODULATION SPECTRUM
(FREQUENCY DOMAIN)

A spectrum analyzer screen showing such modulation contains the three components of the signal plotted in terms of frequency (in the frequency domain). It is very difficult to visualize the components of even the simplest form of modulation in the time domain, since the carrier and sidebands are all varying sinusoidally over time – although at different rates. Normally, complex mathematical expressions are used to explain modulation in the time domain using phasor algebra. Fortunately, it is possible to show the relative "motion" of the carrier and sideband phasors using vector analysis by referencing the degree of rotation of the sidebands to a fixed point in the rotation of the carrier phasor.

The two sidebands of a conventional single-frequency modulated AM signal appear as equal-length vectors that rotate in opposite directions relative to the stationary carrier vector – and are always displaced from it by equal but opposite angles. At the point in the modulated RF envelope where its amplitude is equal to that of the carrier alone, the two sidebands oppose each other to completely cancel in the resultant of the vector addition.

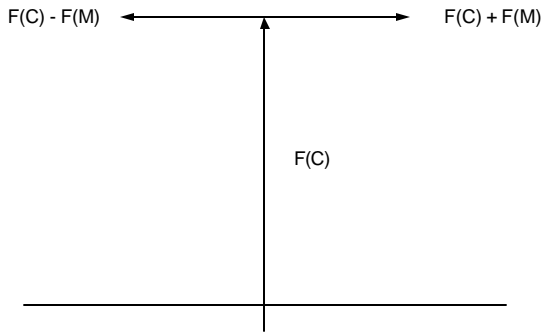

AM SINUSOIDAL MODULATION
(VECTOR REPRESENTATION)

As the sideband vectors rotate so that the resultant is greater than the amplitude alone, the waveform progresses toward a positive modulation peak.

As the two sideband vectors fall in line with each other and the carrier vector, the resultant approaches twice the carrier magnitude to form a 100-percent positive modulation peak.

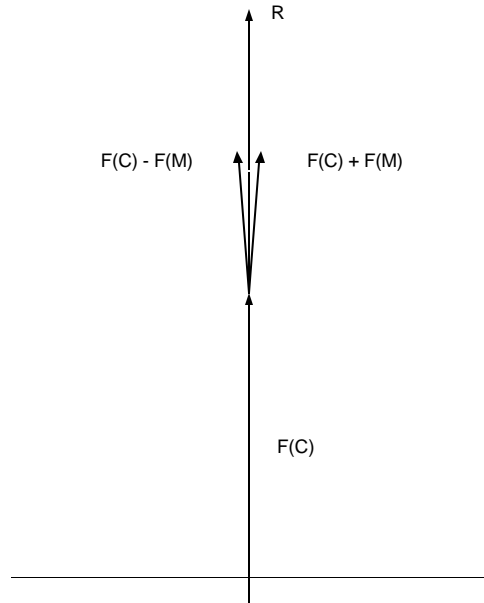

AM SINUSOIDAL MODULATION
(VECTOR REPRESENTATION)

Similarly, when enough time has passed for the two sideband vectors to rotate to the opposite direction, the resultant will approach zero to form a 100-percent negative modulation peak (not shown).

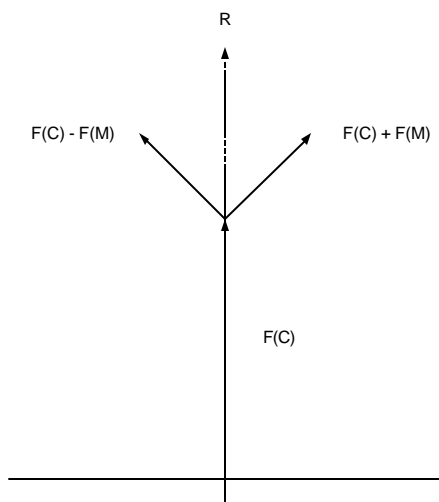

AM SINUSOIDAL MODULATION
(VECTOR REPRESENTATION)

Except when testing with tone modulation, AM signals are much more complicated. The complex waveforms of normal programming have many frequency components. In a perfect system, however, the components will always be divided into equal, symmetrical sideband components.

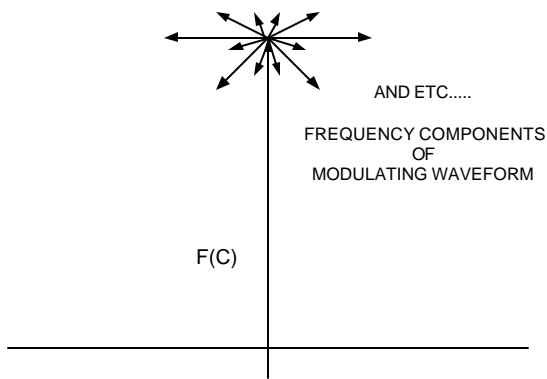

AM COMPLEX MODULATION
(VECTOR REPRESENTATION)

A spectrum analyzer shows the range of frequencies occupied by the various sideband components for normal program modulation.

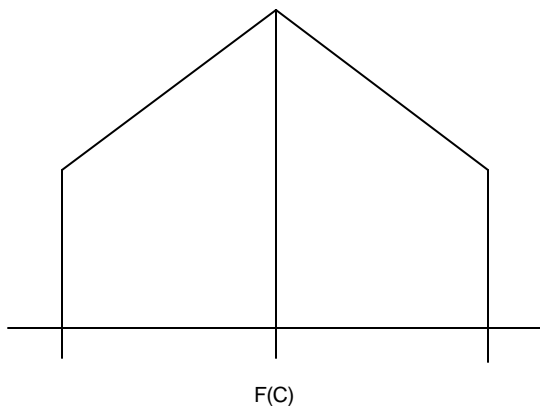

AM COMPLEX MODULATION SPECTRUM
(FREQUENCY DOMAIN)

Suppose that the sidebands vectors are symmetrical about an imaginary line running perpendicular to the carrier vector instead of to the carrier vector itself – in other words, the sidebands of AM transmission are rotated 90 degrees (in quadrature) relative to the carrier. The resultant will not always fall in line with the carrier, but will vary in angle from it over time. This will be fundamentally angle modulation – which, in analog transmission, may be either phase modulation or frequency modulation depending on the process applied to the audio to produce it.

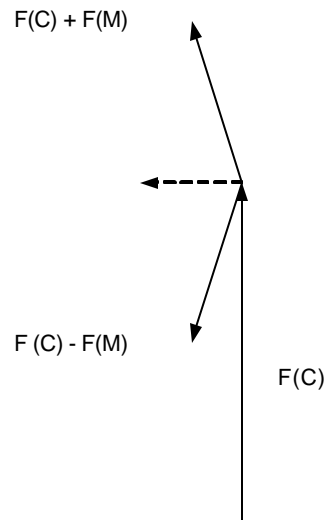

FM - PM MODULATION
FIRST ORDER SIDEBANDS

Careful observation reveals that angle modulation accomplished with only two sidebands for the single-frequency, sinusoidal case would also produce secondary amplitude modulation, since the resultant follows a line tangent to the circle that would be traced by the carrier vector if only its angle were changing. That is why an FM signal has many sidebands even if only a single-frequency tone is being transmitted – the infinite number of harmonically-related sidebands that trail off in amplitude and vary in phase are necessary in order to have the resultant trace the circle rather than the tangent line. Real-World conditions do not permit infinite bandwidth, of course, so at least a small amount of distortion is theoretically unavoidable when FM is transmitted through a bandwidth-limited transmission channel.

DIGITAL TRANSMISSION

Digital transmission utilizes a combination of amplitude and angle modulation to send the bits of information that are decoded by receivers. Such modulation is generally referred to as I-Q modulation, as each bit has a unique combination of I (in phase with the carrier) and Q (in quadrature relative to the carrier) components assigned for it. The following diagram depicts the basic concepts involved in sending a 16-bit digital “constellation” with I-Q modulation superimposed on a conventional AM signal. It is a conceptual sketch only, and does not represent any actual transmission system. It is not to scale.

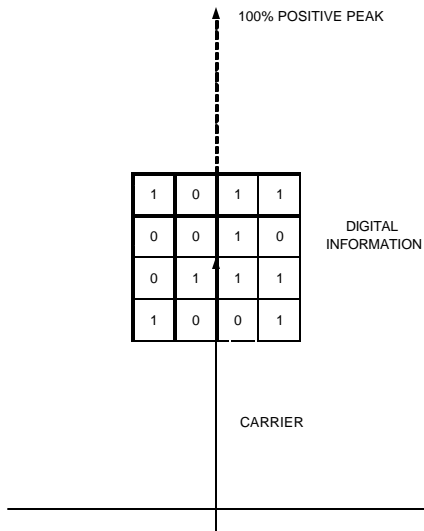

AM + DIGITAL IQ MODULATION

CONCEPTUAL ONLY - NOT TO SCALE

It can be seen that, for the bits to arrive in the correct relationships to be decoded by a receiver, the transmission system must maintain their correct locations in terms of I and Q and they must remain isolated from the AM signal.

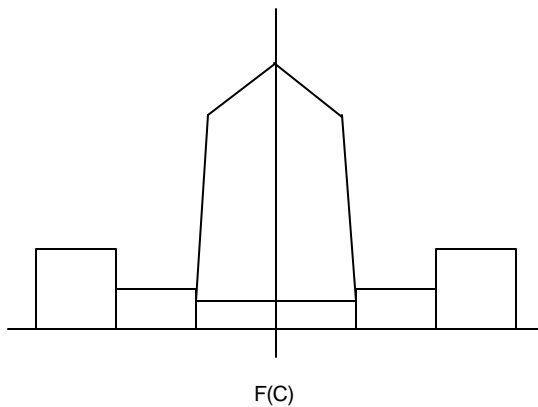

AM IBOC MODULATION SPECTRUM (FREQUENCY DOMAIN)

CONCEPTUAL - NOT TO SCALE

IBOC digital transmission occupies spectrum in addition to that of a conventional AM signal.

TRANSMITTER LOAD OPTIMIZATION

When a transmitter with a perfect modulation system is connected to a perfect load (one which does not change impedance with frequency), perfect transmission of the digital signal will result. Modern transmitters that have been designed to carry digital modulation approach perfection, at least for all practical purposes. Real-world antennas, however, do not.

Since it is not realistic to expect antennas to have input impedances that are constant with frequency, the goal of having the effects of changing impedance at least be symmetrical about the carrier frequency must be pursued. If the load impedances at sideband frequencies differ from the carrier frequency in symmetrical fashion, cross-talk between the digital and analog signals can be minimized.

It is important to note that the symmetry must be provided to the actual active components of the final amplifier, where the process may be most closely simulated by a perfect source. The circuitry that provides impedance matching and bandpass filtering between the final amplifier and the transmitter output port must be considered if it is impossible to make impedance measurements at the final amplifier. Assuming that the output network of a transmitter is adjusted to provide the correct load impedance for the final amplifier at carrier frequency, the most important thing to know about it for sideband symmetry analysis is its phase delay.

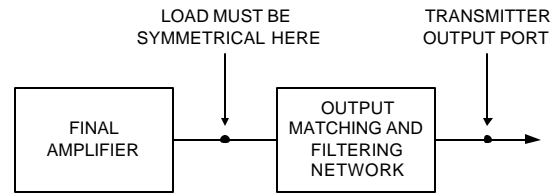

It is most convenient to view impedances as they appear on a Smith Chart when analyzing sideband symmetry. In order to view the important characteristics of the impedances without respect to what the impedance might be at carrier frequency – such as at the final amplifier of a solid state transmitter which operates into an 8 Ohm load or at the common point of a directional antenna system's phasor which might be offset in reactance by several negative ohms to correct for the insertion inductance of a contactor between it and the transmitter – per-unit Smith Charts (referenced to 1.0 rather than a transmission line impedance like 50 Ohms) are used.

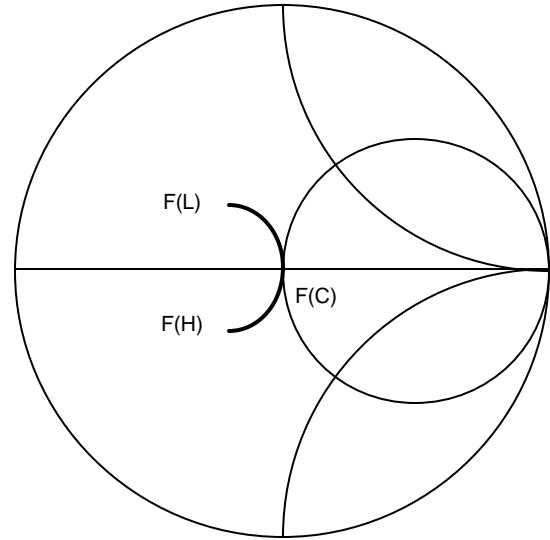
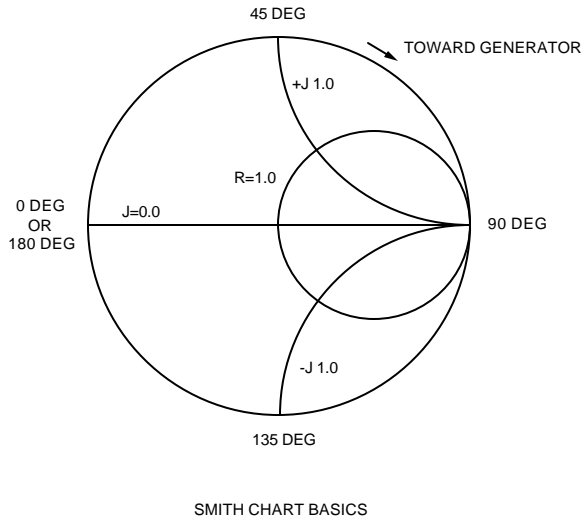

The process of converting an impedance sweep for per-unit analysis is known as normalizing to the carrier frequency impedance. Dividing the resistance at a sideband frequency by the carrier frequency resistance gives the sideband per-unit normalized resistance if the carrier frequency resistance is assigned a value of unity. Dividing the difference in reactance between a sideband frequency and the carrier frequency by the carrier resistance gives the sideband per-unit normalized reactance if the carrier frequency reactance is assigned a value of zero.

FINAL AMPLIFIER LOAD IMPEDANCE SYMMETRY

NORMALIZING PER-UNIT VALUES TO THE CARRIER IMPEDANCE

1. DIVIDE EACH SIDEBAND RESISTANCE BY THE CARRIER RESISTANCE
2. DIVIDE THE DIFFERENCE BETWEEN EACH SIDEBAND REACTANCE AND THE CARRIER REACTANCE BY THE CARRIER RESISTANCE

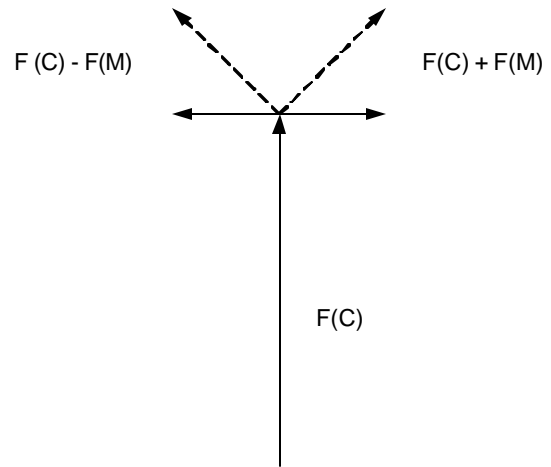

EXAMPLES

FREQUENCY	C.P. RESISTANCE	C.P. REACTANCE	PER-UNIT RESISTANCE	PER-UNIT REACTANCE
- 15 KHZ	45.0	-j 8.0	0.90	-j 0.16
CARRIER	50.0	0.0	1.00	j 0.00
+ 15 KHZ	57.0	+j 10.0	1.14	+j 0.20
- 15 KHZ	45.0	-j 8.0	0.86	-j 0.09
CARRIER	52.5	-j 3.5	1.00	j 0.00
+ 15 KHZ	57.0	+j 10.0	1.09	+j 0.12

SIDEBAND ALTERATION FROM SYMMETRICAL LOAD

A symmetrical impedance sweep will appear on the Smith Chart with equal normalized resistances and equal normalized reactances of opposite sign for equal frequency deviation from the carrier frequency.

For this symmetrical case, the sideband resistances are equal – but lower than the carrier resistance - at both sideband frequencies and the

sideband reactances are symmetrical. If the final amplifier functions as a voltage source, higher power will be delivered to both sidebands than would be the case with a flat load (meaning longer sideband vectors) - resulting in pre-emphasis but not harmonic distortion in the demodulated waveform. . In addition, the opposite reactances will cause both sidebands to be offset by equal but opposite angles relative to the carrier - producing envelope delay, but not harmonic distortion, in the demodulated waveform. Both effects are perfectly acceptable for analog transmission, as long as the transmitter is not driven into nonlinearity to deliver the required sideband power. For digital transmission, the effects on the I-Q constellation will be more easily compensated than would be the case with a nonsymmetrical load. Importantly for IBOC transmission, the symmetry will prevent crosstalk between the digital and analog signals.

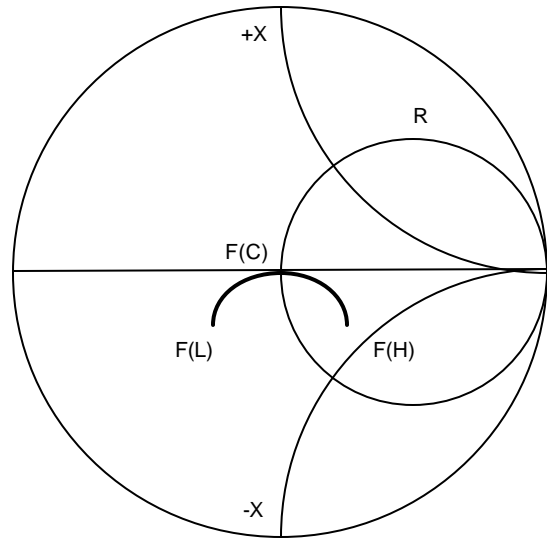

FINAL AMPLIFIER
LOAD IMPEDANCE ASSYMMETRY

Digital-to-analog crosstalk may be the area of most concern for stations initially converting to IBOC transmission. Although a certain amount of hiss-type noise must be tolerated under the carrier of an AM station transmitting the IBOC signal, a very prominent “bacon frying” noise has been noted in certain cases. Thus far, experience indicates that this noise may be significantly decreased by establishing final amplifier load symmetry.

The following case of asymmetrical sideband load impedances shows how the two sideband vectors are altered differently in length and offset differently in angle due to the sideband impedances presented to the final amplifier. It is obvious that the resultant will follow an ellipse over a cycle of the analog modulating frequency rather than the straight line that is traced by a pure AM signal.

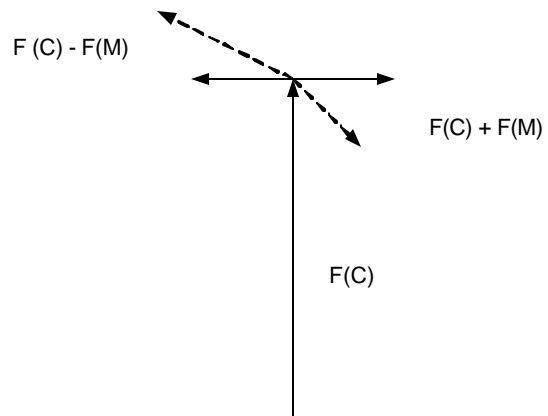

SIDE BAND ALTERATION
FROM ASYMMETRICAL LOAD

Non-symmetrical load impedance characteristics, in addition to causing crosstalk between the digital and analog signals in IBOC transmission, also complicate the error correction process for the digital I-Q constellation - leading to higher bit error rates that erode the reliability of the digital transmission channel. For the same reasons, the analog signal sidebands are altered in such a way as to cause harmonic distortion in the demodulated waveform.

The asymmetrical load in this case can be made to perform identically to the symmetrical load that was considered in the first case by the addition of a -45 degree phase shifting network between the transmitter and the antenna.

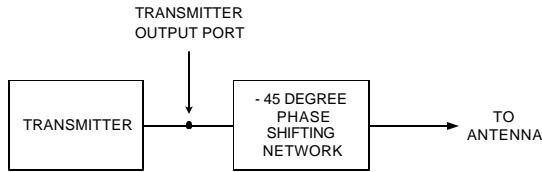

Some loads may not be made symmetrical for the transmitter's final amplifier by simple phase rotation. One method to evaluate the potential for symmetry is to plot the normalized per-unit antenna input impedance on transparent overlay paper over a Smith Chart so that it can be rotated about the reference point to simulate the effects of added phase shift.

It is obvious by inspection that this load will require more than the addition of a phase-shifting network to have final amplifier load symmetry.

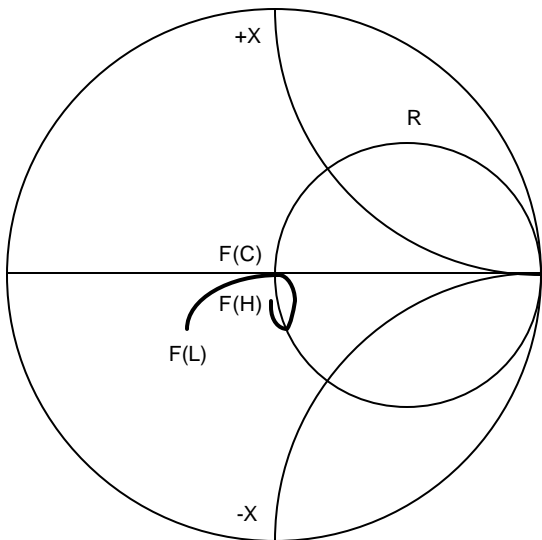

ANTENNA IMPEDANCE ASYMMETRY

IBOC "DESIRED CHARACTERISTICS"

Although there are no universally accepted criteria for evaluating the effects on digital transmission of finite-bandwidth antenna systems, the developer of the digital transmission system that is presently in use in the United States, Ibiquity, has recommended the following "desired characteristics" for antenna systems that transmit with their system:

I. Load Impedance Bandwidth

a. +/- 5 KHz - symmetry of the load impedance presented to the final RF amplifier within the transmitter such that the VSWR calculated for one sideband impedance, when normalized to the complex conjugate of the corresponding sideband impedance on the other side of carrier frequency, does not exceed 1.035:1

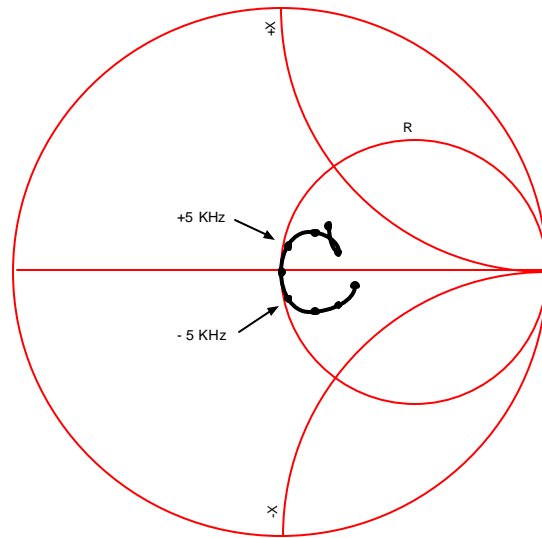

b. +/- 10 KHz - the VSWR of the load impedance presented to the final RF amplifier within the transmitter should not exceed 1.20:1 when normalized to the carrier frequency impedance.

c. +/- 15 KHz - the VSWR of the load impedance presented to the final RF amplifier within the transmitter should not exceed 1.40:1 when normalized to the carrier frequency impedance.

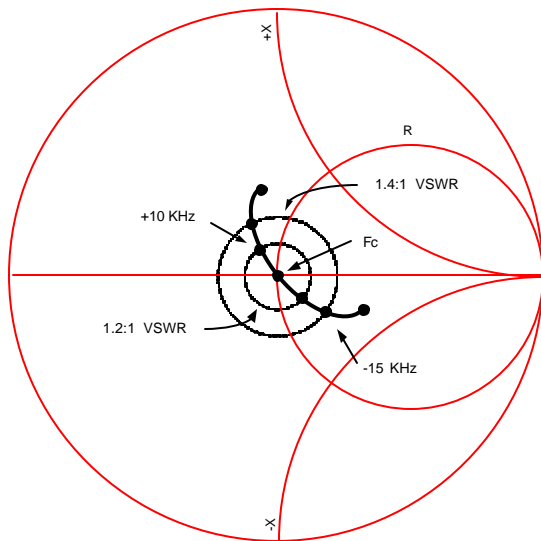

II. Far-Field Radiation Pattern Bandwidth

- a. +/- 15 KHz - Response within +/- 2 dB
- b. +/- 15 KHz - Group delay constant within +/- 5.0 microseconds

These values are preliminary guidelines and are subject to change as more experience is gained with digital transmission. Thus far, experience has shown that the recommendations for sideband VSWR at 10 and 15 KHz from the carrier frequency are very conservative. Loads with higher sideband VSWRS have provided satisfactory performance both in the lab and in the field when the sideband impedances are made near-symmetrical about the carrier frequency [where perfect symmetry would have equal resistance and equal-but-opposite reactance excursions on either side of the carrier frequency].

As explained earlier, the symmetry of the sideband impedances at +/- 5 KHz of carrier frequency has proven to be very important for minimizing digital-to-analog crosstalk. Such crosstalk causes noise that is sometimes described as “bacon frying” underneath the analog signal when digital transmission is underway.

NETWORK ANALYZER MEASUREMENTS

It has been found to be very convenient to use a network analyzer to make the measurements necessary for evaluating antenna system performance for digital transmission. A power-amplified system for making measurements with interference immunity has been developed for this purpose, and was described in the author’s paper which appears in the NAB 2003 Engineering Conference Proceedings.

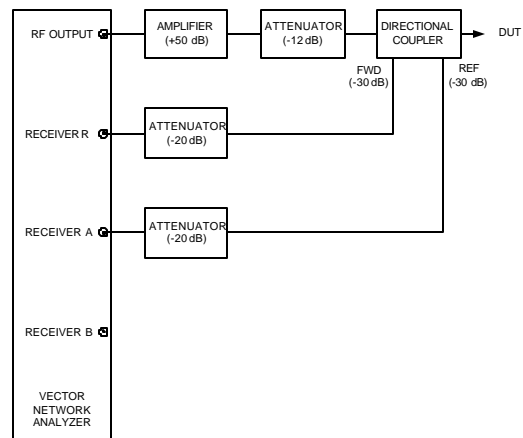

IMPEDANCE MEASUREMENT SYSTEM



IMPEDANCE MEASUREMENTS AT ATU INPUT

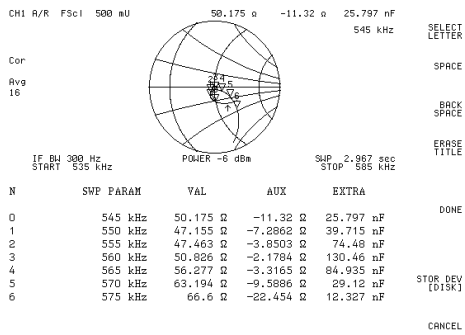

AN IMPEDANCE SWEEP

Another configuration may be used to measure the phase and ratio-vs-frequency characteristics of a directional antenna system's elements. The common point is driven by the directional coupler which derives the signal for the analyzer's reference receiver input. The antenna monitor sampling line of the reference tower is connected to the B receiver's input. The other sampling lines are switched to the A receiver's input and the analyzer is alternately set to measure the magnitude and phase relationships of the A and B inputs for each tower.

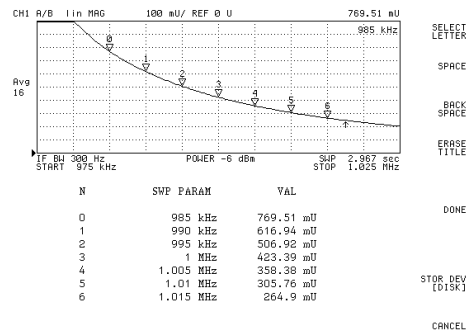

A MEASURED DA TOWER RATIO SWEEP

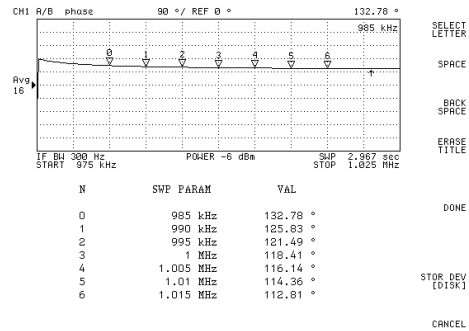

A MEASURED DA TOWER PHASE SWEEP

Information on how the tower ratios and phases vary with frequency may be used to evaluate pattern bandwidth. The measured antenna element parameters at carrier and sideband frequencies may be used to calculate the changes in far-field magnitude and phase that occur at different azimuths, using computer software such as the Mininec Broadcast Professional package. The far-field response may then be calculated directly from the magnitude excursions. The delay characteristics may be calculated from the phase characteristics at the azimuths of interest.

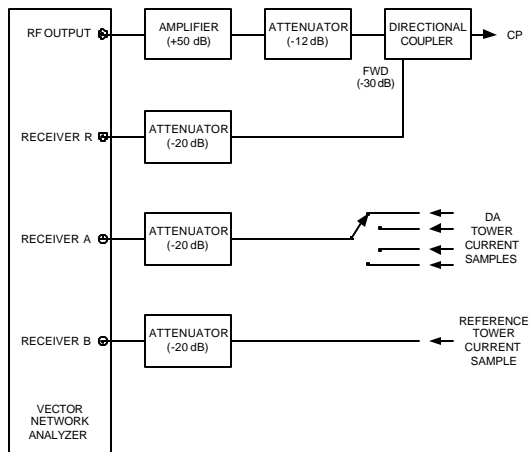

DA PHASE AND RATIO MEASUREMENTS